



2 Runners



3 Runners



With Wheels



%100 Recyclable



Food Grade

Product Details

Product Type	External Dimensions	Internal Dimensions	Weight	Usable Volume
Feet	1000x1200x578 (h)mm	914x1114x420 (h)mm	29.300 gr HDPE (±3%)	400 lt
2 Runners	1000x1200x601 (h)mm		32.600 gr HDPE (±3%)	
3 Runners	1000x1200x601 (h)mm		35.450 gr HDPE (±3%)	
With Wheels	1000x1200x733 (h)mm		33.700 gr HDPE (±3%)	

Loading Capacities

Product Type	Unit Load	Static	Dynamic	Racking
Feet	300 kg	3.000 kg	300 kg	X
2 Runners				300 kg
3 Runners				300 kg
With Wheels				X

Loading Information

Product Type	40'HC	Truck
Feet	88 pcs	104 pcs
2/3 Runners		
With Wheels		

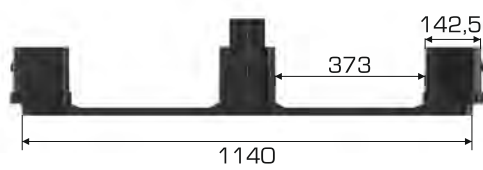
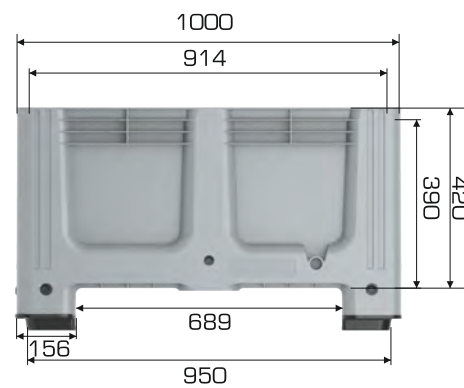
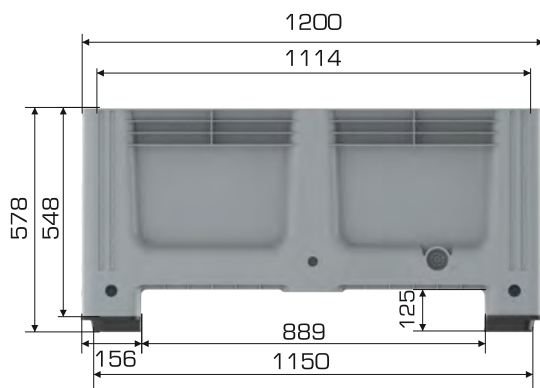

2 Runners

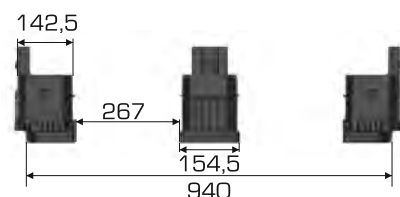

3 Runners

Branding Solutions

Digital Printing	Laser Printing	Screen Printing	Hot Stamping	Cliche	Labeling	RFID
✓	✓	✓	✓	✓	✓	✓